

**4.2 - CAJA CUADRADA. A PRUEBA DE INTEMPERIE. SERIE RC.  
CON OREJAS PARA MONTAJE.**

**4.2 - WEATHERPROOF TWO GANG BOX. RC SERIES.  
WITH MOUNTING LUGS.**

Dimensiones en milímetros y en pulgadas.  
Dimensions in inches and millimeters.



LISTED  
1M70



- Material: Aluminio inyectado a presión (diecast).
- Acabados: Pintura electrostática epoxica/poliester polimerizada.
- Dos tornillos de tierra pasivados incluidos.
- Dos orejas para montaje, tornillos y tapones incluidos.
- A prueba de intemperie cuando se usa tapa con empaque.
- Rosca NPT para usarse con tubo conduit RIGIDO e IMC.

**APLICACIONES:**

- Pueden ser instaladas para recibir accesorios como: Interruptores, contactos, estaciones de botones, luces piloto.
- Sirven para hacer empalmes y conexiones en el cableado. Permite facil acceso para mantenimiento.
- Fabricación en base a: UL 514 A, UL 514 B  
CAN/CSA-C22.2 No. 18-92

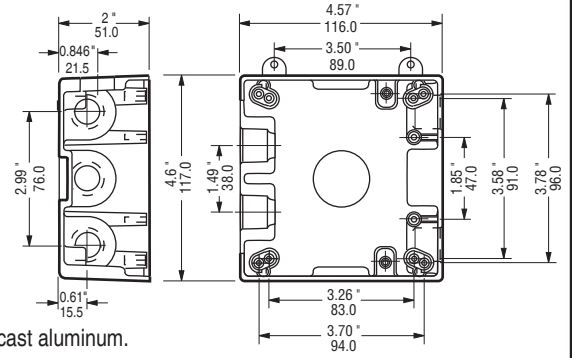

- Material: Diecast aluminum.
- Finish: Electrostatic powder epoxy/poliester coating.
- Two green ground screws included.
- Two mounting lugs, screws and close-up plugs included.
- For wet location when gasketed cover are used.
- NPT threaded for use with RIGID and IMC conduit.

**APPLICATIONS:**

- They can be installed to accommodate accessories such as switches, receptacles.
- Provide openings for making splice and taps. Allow access for maintenance.
- Manufactured in compliance with: UL 514 A, UL 514 B  
CAN/CSA-C22.2 No. 18-92

USAR No. DE CODIGO PARA HACER PEDIDOS / TO ORDER USE CODE NUMBER

Figura Figure	Bocas Hubs	Catalogo Catalog	Codigo Code	Medida nominal Hub size		Volumen Volume		Peso x 100 pzas. Weight x 100 pcs.		Pqt. Unit. Pzas. Pcs.	Std. Pkg. Pzas. Pcs.	
				mm	inch.	cm <sup>3</sup>	cu. in	kg	Lb			
	Arriba/Top	1	RC-0482-M	02.01.0482.M	12.7	1/2	492.0	30.0	42.5	93.6	1	24
	Abajo/Bottom	1	RC-0483-M	02.01.0483.M	19.0	3/4	492.0	30.0	41.0	90.3	1	24
	Arriba/Top	2	RC-0484-M	02.01.0484.M	12.7	1/2	483.8	29.5	42.5	93.6	1	24
	Abajo/Bottom	1	RC-0485-M	02.01.0485.M	19.0	3/4	483.8	29.5	39.0	85.9	1	24
	Arriba/Top	1	RC-0502-M	02.01.0502.M	12.7	1/2	492.0	30.0	42.0	92.5	1	24
	Abajo/Bottom	1	RC-0503-M	02.01.0503.M	19.0	3/4	492.0	30.0	39.5	87.0	1	24
	Izquierda/Left	1	RC-0503-M	02.01.0503.M	19.0	3/4	492.0	30.0	39.5	87.0	1	24
	Arriba/Top	1	RC-0486-M	02.01.0486.M	12.7	1/2	492.0	30.0	41.5	91.4	1	24
	Abajo/Bottom	1	RC-0487-M	02.01.0487.M	19.0	3/4	492.0	30.0	39.0	85.9	1	24
	Izquierda/Left	1	RC-0487-M	02.01.0487.M	19.0	3/4	492.0	30.0	39.0	85.9	1	24
	Derecha/Right	1	RC-0487-M	02.01.0487.M	19.0	3/4	492.0	30.0	39.0	85.9	1	24
	Arriba/Top	2	RC-0488-M	02.01.0488.M	12.7	1/2	475.0	29.5	48.38	91.4	1	24
	Abajo/Bottom	1	RC-0489-M	02.01.0489.M	19.0	3/4	475.0	29.5	48.38	83.7	1	24
	Izquierda/Left	1	RC-0489-M	02.01.0489.M	19.0	3/4	475.0	29.5	48.38	83.7	1	24

Especificaciones sujetas a cambio sin previo aviso. Specifications are subject to change without notice.

**RAWELT, S.A. de C.V.**



Una División del Grupo REVUELTA

**4.2 - CAJA CUADRADA. A PRUEBA DE INTEMPERIE. SERIE RC.  
CON OREJAS PARA MONTAJE.**

**4.2 - WEATHERPROOF TWO GANG BOX. RC SERIES.  
WITH MOUNTING LUGS.**

Hoja: 2 / 8  
Page:

FICHA TECNICA / TECHNICAL DATA

007-RW-172

USAR No. DE CODIGO PARA HACER PEDIDOS / TO ORDER USE CODE NUMBER

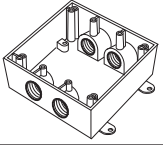
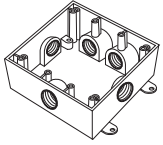
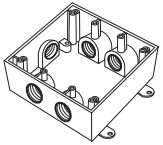
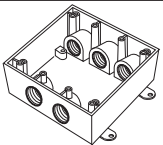
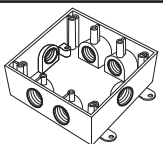
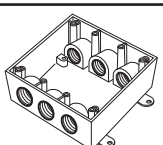
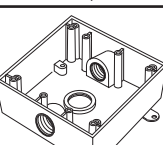
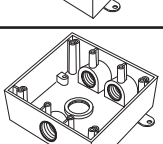
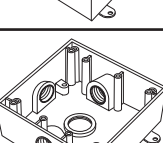
Figura Figure	Bocas Hubs	Catalogo Catalog	Codigo Code	Medida nominal Hub size		Volumen Volume		Peso x 100 pzas. Weight x 100 pcs.		Pqt. Unit. Pzas. Pcs.	Std. Pkg. Pzas. Pcs.
				mm	inch.	cm <sup>3</sup>	cu. in	kg	Lb		
	Arriba/Top 2	RC-0492-M	02.01.0492.M	12.7	1/2	480.5	29.3	43.0	94.7	1	24
	Abajo/Bottom 2	RC-0493-M	02.01.0493.M	19.0	3/4	480.5	29.3	38.0	83.7	1	24
	Arriba/Top 2	RC-0490-M	02.01.0490.M	12.7	1/2	483.8	29.5	41.0	90.3	1	24
	Abajo/Bottom 1	RC-0491-M	02.01.0491.M	19.0	3/4	483.8	29.5	37.0	81.5	1	24
	Izquierda/Left 1										
	Arriba/Top 2	RC-0494-M	02.01.0494.M	12.7	1/2	480.5	29.3	42.0	92.5	1	24
	Abajo/Bottom 2	RC-0495-M	02.01.0495.M	19.0	3/4	480.5	29.3	37.0	81.5	1	24
	Izquierda/Left 1										
	Arriba/Top 3	RC-0498-M	02.01.0498.M	12.7	1/2	475.6	29.0	44.5	98.1	1	24
	Abajo/Bottom 2	RC-0499-M	02.01.0499.M	19.0	3/4	475.6	29.0	39.5	87.0	1	24
	Arriba/Top 2	RC-0496-M	02.01.0496.M	12.7	1/2	480.5	29.3	41.5	91.4	1	24
	Abajo/Bottom 2	RC-0497-M	02.01.0497.M	19.0	3/4	480.5	29.3	36.0	79.3	1	24
	Izquierda/Left 1										
	Arriba/Top 3	RC-0500-M	02.01.0500.M	12.7	1/2	472.3	28.8	45.0	99.2	1	24
	Abajo/Bottom 3	RC-0501-M	02.01.0501.M	19.0	3/4	472.3	28.8	38.5	84.8	1	24
	Arriba/Top 1	RC-0279-M	02.01.0279.M	12.7	1/2	492.0	30.0	42.0	92.5	1	24
	Abajo/Bottom 1	RC-0280-M	02.01.0280.M	19.0	3/4	492.0	30.0	40.5	89.2	1	24
	Detrás/Back 1										
	Arriba/Top 2	RC-0327-M	02.01.0327.M	12.7	1/2	483.8	29.5	42.0	92.5	1	24
	Abajo/Bottom 1	RC-0328-M	02.01.0328.M	19.0	3/4	483.8	29.5	38.5	84.8	1	24
	Detrás/Back 1										
	Arriba/Top 1	RC-0406-M	02.01.0406.M	12.7	1/2	492.0	30.0	41.5	91.4	1	24
	Abajo/Bottom 1	RC-0407-M	02.01.0407.M	19.0	3/4	492.0	30.0	39.0	85.9	1	24
	Izquierda/Left 1										
	Detrás/Back 1										

Especificaciones sujetas a cambio sin previo aviso. Specifications are subject to change without notice.

**RAWELT, S.A. de C.V.**



Una División del Grupo REVUELTA

**4.2 - CAJA CUADRADA. A PRUEBA DE INTEMPERIE. SERIE RC.  
CON OREJAS PARA MONTAJE.**



**4.2 - WEATHERPROOF TWO GANG BOX. RC SERIES.  
WITH MOUNTING LUGS.**

Hoja: 3 / 8  
Page:

FICHA TECNICA / TECHNICAL DATA

007-RW-172

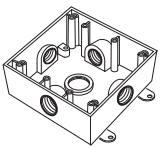
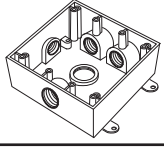
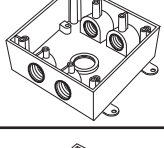
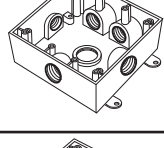
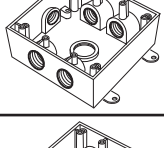
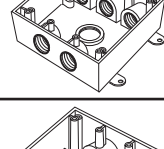
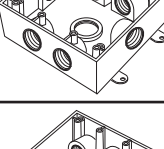
USAR No. DE CODIGO PARA HACER PEDIDOS / TO ORDER USE CODE NUMBER

Figura Figure	Bocas Hubs	Catalogo Catalog	Codigo Code	Medida nominal Hub size		Volumen Volume		Peso x 100 pzas. Weight x 100 pcs.		Pqt. Unit. Pzas. Pcs.	Std. Pkg. Pzas. Pcs.	
				mm	inch.	cm <sup>3</sup>	cu. in	kg	Lb			
	Arriba/Top	1	RC-0390-M	02.01.0390.M	12.7	1/2	492.0	30.0	41.0	90.3	1	24
	Abajo/Bottom	1										
	Izquierda/Left	1	RC-0391-M	02.01.0391.M	19.0	3/4	492.0	30.0	38.5	84.8	1	24
	Derecha/Right	1										
Detrás/Back	1											
	Arriba/Top	2	RC-0392-M	02.01.0392.M	12.7	1/2	483.8	29.5	41.0	90.3	1	24
	Abajo/Bottom	1										
	Izquierda/Left	1	RC-0393-M	02.01.0393.M	19.0	3/4	483.8	29.5	37.5	82.6	1	24
	Detrás/Back	1										
	Arriba/Top	2	RC-0396-M	02.01.0396.M	12.7	1/2	480.5	29.3	42.5	93.6	1	24
	Abajo/Bottom	2										
	Detrás/Back	1	RC-0397-M	02.01.0397.M	19.0	3/4	480.5	29.3	37.5	82.6	1	24
	Arriba/Top	2	RC-0394-M	02.01.0394.M	12.7	1/2	483.8	29.5	40.5	89.2	1	24
	Abajo/Bottom	1										
	Izquierda/Left	1	RC-0395-M	02.01.0395.M	19.0	3/4	483.8	29.5	36.5	80.4	1	24
	Derecha/Right	1										
Detrás/Back	1											
	Arriba/Top	2	RC-0398-M	02.01.0398.M	12.7	1/2	480.5	29.3	41.5	91.4	1	24
	Abajo/Bottom	2										
	Izquierda/Left	1	RC-0399-M	02.01.0399.M	19.0	3/4	480.5	29.3	36.5	80.4	1	24
	Detrás/Back	1										
	Arriba/Top	3	RC-0402-M	02.01.0402.M	12.7	1/2	475.6	29.0	44.0	97.0	1	24
	Abajo/Bottom	2										
	Detrás/Back	1	RC-0403-M	02.01.0403.M	19.0	3/4	475.6	29.0	39.0	85.9	1	24
	Arriba/Top	2	RC-0400-M	02.01.0400.M	12.7	1/2	480.5	29.3	41.0	90.3	1	24
	Abajo/Bottom	2										
	Izquierda/Left	1	RC-0401-M	02.01.0401.M	19.0	3/4	480.5	29.3	35.5	78.2	1	24
	Derecha/Right	1										
Detrás/Back	1											
	Arriba/Top	3	RC-0404-M	02.01.0404.M	12.7	1/2	472.3	28.8	44.5	98.1	1	24
	Abajo/Bottom	3										
	Detrás/Back	1	RC-0405-M	02.01.0405.M	19.0	3/4	472.3	28.8	38.0	83.7	1	24

Certificaciones / Compliances:  Expediente/File No. LR 105795-1  Expediente/File No. E135600

Especificaciones sujetas a cambio sin previo aviso. Specifications are subject to change without notice..

**RAWELT, S.A. de C.V.**

 **RAWELT**® INYECTADOS  
Una División del Grupo  **REVUELTA**

**4.2 - CAJA CUADRADA. A PRUEBA DE INTEMPERIE. SERIE RC.  
CON OREJAS PARA MONTAJE. TAPA CUADRADA ALUMINIO.**

Hoja: 4 / 8  
Page:

**4.2 - WEATHERPROOF TWO GANG BOX. RC SERIES.  
WITH MOUNTING LUGS. TWO GANG COVER ALUMINUM.**

FICHA TECNICA / TECHNICAL DATA

007-RW-172

**TAPA**

- Lámina de aluminio troquelada.
- Uso en interiores.
- Tornillos galvanizados incluidos.

**COVER**

- Sheet aluminum.
- For use in interiors.
- Galvanized mounting screws included.

Dimensiones en milímetros y pulgadas.  
Dimensions in inches and millimeters.

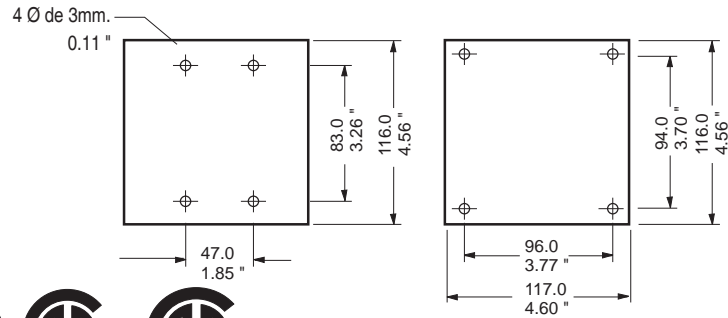

**EMPAQUE**

- PVC

**GASKET**

- PVC.

**TAPON**

- Aluminio inyectado a presión. (die cast)

**CLOSE UP PLUG**

- Die cast aluminum.



USAR No. DE CODIGO PARA HACER PEDIDOS / TO ORDER USE CODE NUMBER

Figura Figure	Catalogo Catalog	Codigo Code	Descripción Description	Cant. Diam. Qty.	Espesor Thickness		Peso x 100 pzas. Weight x 100 pcs.		Pqt. Unit Pzas. Pcs.	Unit Ctn. Pzas. Pcs.	Ship Ctn. Pzas. Pcs.	Std. Pkg. Pzas. Pcs.
					mm	inch	kg	Lb				
	TC-0417	02.02.0417	Tapa cuadrada para dos contactos duplex. 4 diámetros. Two gang two duplex receptacles cover. Box mount. 4 holes.	4	1.02	.040	2.9	6.4	10	40	160	200
	TC-0457	02.02.0457	Tapa cuadrada para dos contactos duplex. 2 diámetros. Two gang two duplex receptacles cover. Device mount. 2 holes.	2	1.02	.040	3.0	6.6	10	40	160	200
	TC-0419	02.02.0419	Tapa cuadrada para dos interruptores. 4 diámetros. Two gang two toggles switches cover. Box mount. 4 holes.	4	1.02	.040	3.7	8.2	10	40	160	200
	TC-0459	02.02.0459	Tapa cuadrada para dos interruptores. 4 diámetros. Two gang two toggles switches cover. Device mount. 4 holes.	4	1.02	.040	3.7	8.2	10	40	160	200
	TC-0510	02.02.0510	Tapa cuadrada para contacto duplex y apagador. 4 diámetros. Two gang toggle switch and duplex receptaclecover. Box mount. 4 holes.	4	1.02	.040	3.3	7.2	10	40	160	200
	TC-0511	02.02.0511	Tapa cuadrada para contacto duplex y apagador. 3 diámetros. Two gang toggle switch and duplex receptaclecover. Device mount. 3 holes.	3	1.02	.040	3.3	7.2	10	40	160	200
	TC-0418 EPC-3972	02.02.1311.G	Tapa cuadrada ciega con empaque. 4 diámetros. Weatherproof two gang blank cover. Box mount with gasket. 4 holes.	4	1.02	.040	3.9	8.6	10	40	120	200
	TC-0458 EPC-3972	02.02.1312.G	Tapa cuadrada ciega con empaque. 4 diámetros. Weatherproof two gang blank cover. Device mount with gasket. 4 holes.	4	1.02	.040	3.9	8.6	10	40	120	200

Especificaciones sujetas a cambio sin previo aviso. Specifications are subject to change without notice..

**RAWELT, S.A. de C.V.**



**4.2 - CAJA CUADRADA. A PRUEBA DE INTEMPERIE. SERIE RC.  
CON OREJAS PARA MONTAJE. TAPA CUADRADA ALUMINIO.**

**4.2 - WEATHERPROOF TWO GANG BOX. RC SERIES.  
WITH MOUNTING LUGS. TWO GANG COVER ALUMINUM.**

Hoja: 5 / 8  
Page:

FICHA TECNICA / TECHNICAL DATA

**007-RW-172**

USAR No. DE CODIGO PARA HACER PEDIDOS / TO ORDER USE CODE NUMBER

Figura Figure	Catalogo Catalog	Codigo Code	Descripción Description	Cant. Diam. Qty.	Espesor Thickness		Peso x 100 pzas. Weight x 100 pcs.		Pqt. Unit Pzas. Pcs.	Unit Ctn. Pzas. Pcs.	Ship Ctn. Pzas. Pcs.
					mm.	inch	Kg	Lb			
	EPC-3972	08.06.3972	Empaque de PVC tipo cuadrado. PVC gasket.	4	1.6	1/16	1.6	3.5	10	120	480

**TAPONES / PLUGS**

USAR No. DE CODIGO PARA HACER PEDIDOS / TO ORDER USE CODE NUMBER

Figura Figure	Catalogo Catalog	Codigo Code	Descripción Description	Medida nominal Hub size		Peso x 100 pzas. Weight x 100 pcs.		Pqt. Unit Pzas. Pcs.	Unit Ctn. Pzas. Pcs.	Ship Ctn. Pzas. Pcs.
				mm	inch.	kg	Lb			
	TA-0371 TA-0368	01.04.0371 01.04.0368	Tapón roscado Close-up plug.	12.7 19.0	1/2 3/4	1.0 1.3	2.2 2.9	25 25	200 100	2000 1000

Certificaciones / Compliances:



Expediente/File No. LR 105795-1



Expediente/File No. E135600



Tapones  
Closure plugs

Especificaciones sujetas a cambio sin previo aviso. Specifications are subject to change without notice..

**RAWELT, S.A. de C.V.**



**RAWELT**

INYECTADOS

Una División del Grupo **REVUELTA**

**4.2 - CAJA CUADRADA. A PRUEBA DE INTEMPERIE. SERIE RC.  
CON OREJAS PARA MONTAJE.**

Hoja: 6 / 8  
Page:

**4.2 - WEATHERPROOF TWO GANG BOX. RC SERIES.  
WITH MOUNTING LUGS.**

FICHA TECNICA / TECHNICAL DATA

007-RW-172

**TAPA**

- Material: Aluminio inyectado a presión (diecast).
- Acabados: Pintura electrostática epoxica/poliester polimerizada.
- Para uso en interiores y exteriores.
- Provee protección contra la intemperie cuando el receptaculo no esta en uso.
- Empaque y tornillos galvanizados incluidos.
- Contratapa con mecanismo de auto-cierre.

**COVER**

- Diecast aluminum.
- Finish: Electrostatic powder epoxy/poliester coating.
- For use indoors and outdoors.
- Provides weatherproof protection when the receptacle is not in use.
- Gasket and galvanized mounting screws included.
- Self-closing cover.

USAR No. DE CODIGO PARA HACER PEDIDOS / TO ORDER USE CODE NUMBER

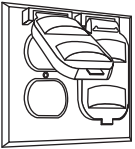
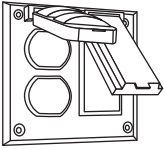
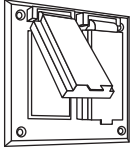
Figura Figure	Catalogo Catalog	Codigo Code	Descripción Description	Cant. Diam. Qty.	Peso x 100 pzas. Weight x 100 pcs.		Pqt. Unit Pzas. Pcs.	Unit Ctn. Pzas. Pcs.	Ship Ctn. Pzas. Pcs.	Std Pkg. Pzas. Pcs.
					Kg	Lb				
	TC-0568	02.03.0568	Tapa cuadrada a prueba de intemperie para 2 contactos duplex. Weatherproof two gang cover for 2 duplex receptacles.	2	24.5	54.0	1	8	32	64
	TC-3252	02.03.3252	Tapa cuadrada a prueba de intemperie para 1 contacto duplex y 1 contacto GFCI. Weatherproof two gang cover for 1 duplex receptacle and 1 GFCI receptacle.	4	24.0	53.0	1	8	32	64
	TC-3253	02.03.3253	Tapa cuadrada a prueba de intemperie para 2 contactos GFCI. Weatherproof two gang cover for 2 GFCI receptacles.	4	23.0	51.0	1	8	32	64

Especificaciones sujetas a cambio sin previo aviso. Specifications are subject to change without notice.

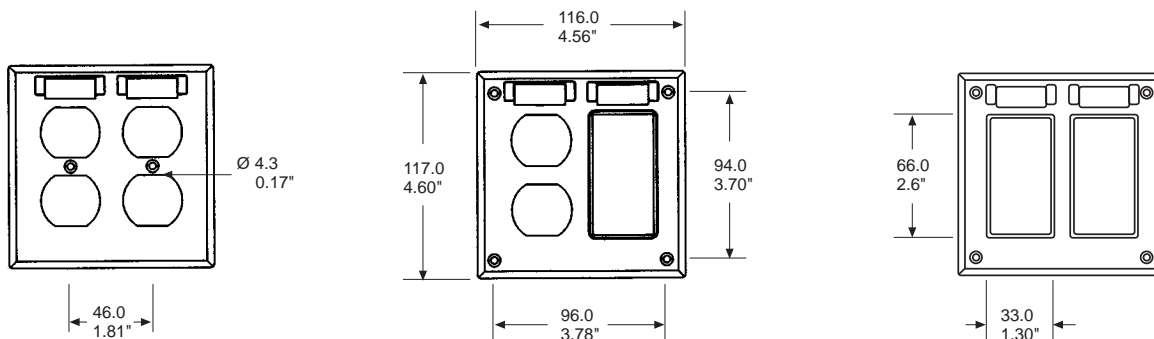

Dimensiones en milímetros y pulgadas. Dimensions in millimeters and inches.

**RAWELT, S.A. de C.V.**

**RAWELT** INYECTADOS  
Una División del Grupo REVUELTA

**4.2 - CAJA CUADRADA. A PRUEBA DE INTEMPERIE. SERIE RC.  
CON OREJAS PARA MONTAJE. TAPA CUADRADA INOXIDABLE.**

**4.2 - WEATHERPROOF TWO GANG BOX. RC SERIES.  
WITH MOUNTING LUGS. TWO GANG COVER STAINLESS STEEL.**

Hoja: 7 / 8  
Page:

FICHA TECNICA / TECHNICAL DATA

007-RW-172

**TAPA**

- Lámina de acero inoxidable troquelada.
- Uso en interiores y exteriores.
- Tornillos de acero inoxidable incluidos.

**EMPAQUE**

- PVC

**TAPON**

- Aluminio inyectado a presión.(die cast)

**COVER**

- Stainless steel sheet.
- For use in interiors and exteriors.
- Stainless steel mounting screws included.

**GASKET**

- PVC

**CLOSE UP PLUG**

- Die cast aluminum.

Dimensiones en milímetros y pulgadas.  
Dimensions in inches and millimeters.

4 Ø de 3mm.  
0.11"

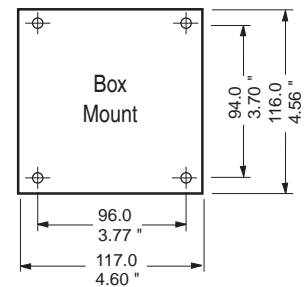
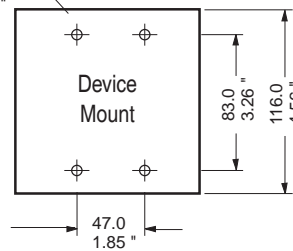

USAR No. DE CODIGO PARA HACER PEDIDOS / TO ORDER USE CODE NUMBER

Figura Figure	Catalogo Catalog	Codigo Code	Descripción Description	Cant. Diam. Qty.	Espesor Thickness		Peso x 100 pzas. Weight x 100 pcs.		Pqt. Unit Pzas. Pcs.	Unit Ctn. Pzas. Pcs.	Ship Ctn. Pzas. Pcs.	Std. Pkg. Pzas. Pcs.
					mm	inch	kg	Lb				
	TC-0417.IX	02.02.4047.IX	Tapa cuadrada para dos contactos duplex. Inoxidable. 4 diámetros. Two gang two duplex receptacles cover. Box mount. Stainless steel. 4 holes.	4	1.02	.040	2.9	6.4	10	40	160	200
	TC-0457.IX	02.02.4048.IX	Tapa cuadrada para dos contactos duplex. Inoxidable. 2 diámetros. Two gang two duplex receptacles cover. Device mount. Stainless steel. 2 holes.	2	1.02	.040	3.0	6.6	10	40	160	200
	TC-0419.IX	02.02.4049.IX	Tapa cuadrada para dos interruptores. Inoxidable. 4 diámetros. Two gang two toggles switches cover. Box mount. Stainless steel. 4 holes.	4	1.02	.040	3.7	8.2	10	40	160	200
	TC-0459.IX	02.02.4050.IX	Tapa cuadrada para dos interruptores. Inoxidable. 4 diámetros. Two gang two toggles switches cover. Device mount. Stainless Steel. 4 holes.	4	1.02	.040	3.7	8.2	10	40	160	200
	TC-0510.IX	02.02.4051.IX	Tapa cuadrada para contacto duplex y apagador. Inoxidable. 4 diámetros. Two gang toggle switch and duplex receptacle cover. Box mount. Stainless steel. 4 holes.	4	1.02	.040	3.3	7.2	10	40	160	200
	TC-0511.IX	02.02.4052.IX	Tapa cuadrada para contacto duplex y apagador. Inoxidable. 3 diámetros. Two gang toggle switch and duplex receptacle cover. Device mount. Stainless steel. 3 holes.	3	1.02	.040	3.3	7.2	10	40	160	200
	TC-0418.IX EPC-3972	02.02.4053.IX	Tapa cuadrada ciega con empaque. Inoxidable. 4 diámetros. Weatherproof two gang blank cover. Box mount with gasket. Stainless steel. 4 holes.	4	1.02	.040	3.9	8.6	10	40	120	200
	TC-0458.IX EPC-3972	02.02.4054.IX	Tapa cuadrada ciega con empaque. Inoxidable. 4 diámetros. Weatherproof two gang blank cover. Device mount with gasket. Stainless steel. 4 holes.	4	1.02	.040	3.9	8.6	10	40	120	200

Especificaciones sujetas a cambio sin previo aviso. Specifications are subject to change without notice..

**RAWELT, S.A. de C.V.**

**RAWELT** INYECTADOS  
Una División del Grupo REVUELTA

4.2 - CAJA CUADRADA. A PRUEBA DE INTEMPERIE. SERIE RC.  
CON OREJAS PARA MONTAJE. TAPA CUADRADA INOXIDABLE.

Hoja: 8 / 8  
Page:

4.2 - WEATHERPROOF TWO GANG BOX. RC SERIES.  
WITH MOUNTING LUGS. TWO GANG COVER STAINLESS STEEL.

FICHA TECNICA / TECHNICAL DATA

007-RW-172

USAR No. DE CODIGO PARA HACER PEDIDOS / TO ORDER USE CODE NUMBER

Figura Figure	Catalogo Catalog	Codigo Code	Descripción Description	Cant. Diam. Qty.	Espesor Thickness		Peso x 100 pzas. Weight x 100 pcs.		Pqt. Unit Pzas. Pcs.	Unit Ctn. Pzas. Pcs.	Ship Ctn. Pzas. Pcs.
					mm.	inch	Kg	Lb			
	EPC-3972	08.06.3972	Empaque de PVC tipo cuadrado. PVC gasket.	4	1.6	1/16	1.6	3.5	10	120	480

TAPONES / PLUGS

USAR No. DE CODIGO PARA HACER PEDIDOS / TO ORDER USE CODE NUMBER

Figura Figure	Catalogo Catalog	Codigo Code	Descripción Description	Medida nominal Hub size		Peso x 100 pzas. Weight x 100 pcs.		Pqt. Unit Pzas. Pcs.	Unit Ctn. Pzas. Pcs.	Ship Ctn. Pzas. Pcs.
				mm	inch.	kg	Lb			
	TA-0371 TA-0368	01.04.0371 01.04.0368	Tapón roscado Close-up plug.	12.7 19.0	1/2 3/4	1.0 1.3	2.2 2.9	25 25	200 100	2000 1000

Certificaciones / Compliances:  Expediente/File No. LR 105795-1



Expediente/File No. E135600

 Tapones  
Closure plugs

Especificaciones sujetas a cambio sin previo aviso. Specifications are subject to change without notice..

**RAWELT, S.A. de C.V.**

 **RAWELT** INYECTADOS

Una División del Grupo **REVUELTA** 

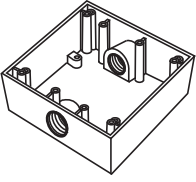
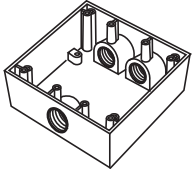
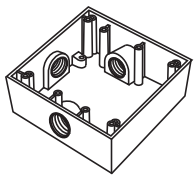
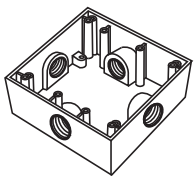
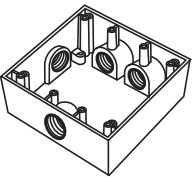
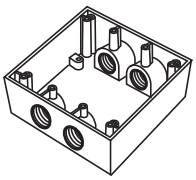

**TABLA DE EQUIVALENCIAS.  
CROSS REFERENCE GUIDE.**

	<b>2 ENTRADAS / 2 HUBS</b>				
	<b>Medida Nominal Size</b>	<b>RAWELT</b>		<b>PERFECT LINE</b>	<b>BWF</b>
		<b>Código Code</b>	<b>Catalogo Catalog</b>	<b>Catalogo Catalog</b>	<b>Catalogo Catalog</b>
	1/2	Sin orejas	02.01.0482	RC-0482	
	3/4	W/out lugs	02.01.0483	RC-0483	
	1/2	Con orejas	02.01.0482.M	RC-0482-M	
3/4	With lugs	02.01.0483.M	RC-0485-M		
	<b>3 ENTRADAS / 3 HUBS</b>				
	<b>Medida Nominal Size</b>	<b>RAWELT</b>		<b>PERFECT LINE</b>	<b>BWF</b>
		<b>Código Code</b>	<b>Catalogo Catalog</b>	<b>Catalogo Catalog</b>	<b>Catalogo Catalog</b>
	1/2	Sin orejas	02.01.0484	RC-0484	
	3/4	W/out lugs	02.01.0485	RC-0485	
	1/2	Con orejas	02.01.0484.M	RC-0484-M	
3/4	With lugs	02.01.0485.M	RC-0485-M		
	<b>3 ENTRADAS / 3 HUBS</b>				
	<b>Medida Nominal Size</b>	<b>RAWELT</b>		<b>PERFECT LINE</b>	<b>BWF</b>
		<b>Código Code</b>	<b>Catalogo Catalog</b>	<b>Catalogo Catalog</b>	<b>Catalogo Catalog</b>
	1/2	Sin orejas	02.01.0502	RC-0502	
	3/4	W/out lugs	02.01.0503	RC-0503	
	1/2	Con orejas	02.01.0502.M	RC-0502-M	
3/4	With lugs	02.01.0503.M	RC-0503-M		
	<b>3 ENTRADAS / 3 HUBS</b>				
	<b>Medida Nominal Size</b>	<b>RAWELT</b>		<b>PERFECT LINE</b>	<b>BWF</b>
		<b>Código Code</b>	<b>Catalogo Catalog</b>	<b>Catalogo Catalog</b>	<b>Catalogo Catalog</b>
	1/2	Sin orejas	02.01.0486	RC-0486	
	3/4	W/out lugs	02.01.0487	RC-0487	
	1/2	Con orejas	02.01.0486.M	RC-0486-M	
3/4	With lugs	02.01.0487.M	RC-0487-M		
	<b>4 ENTRADAS / 4 HUBS</b>				
	<b>Medida Nominal Size</b>	<b>RAWELT</b>		<b>PERFECT LINE</b>	<b>BWF</b>
		<b>Código Code</b>	<b>Catalogo Catalog</b>	<b>Catalogo Catalog</b>	<b>Catalogo Catalog</b>
	1/2	Sin orejas	02.01.0488	RC-0488	
	3/4	W/out lugs	02.01.0489	RC-0489	
	1/2	Con orejas	02.01.0488.M	RC-0488-M	
3/4	With lugs	02.01.0489.M	RC-0489-M		
	<b>4 ENTRADAS / 4 HUBS</b>				
	<b>Medida Nominal Size</b>	<b>RAWELT</b>		<b>PERFECT LINE</b>	<b>BWF</b>
		<b>Código Code</b>	<b>Catalogo Catalog</b>	<b>Catalogo Catalog</b>	<b>Catalogo Catalog</b>
	1/2	Sin orejas	02.01.0492	RC-0492	
	3/4	W/out lugs	02.01.0493	RC-0493	
	1/2	Con orejas	02.01.0492.M	RC-0492-M	
3/4	With lugs	02.01.0493.M	RC-0493-M		

**TABLA DE EQUIVALENCIAS.  
CROSS REFERENCE GUIDE.**

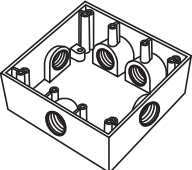
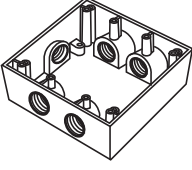
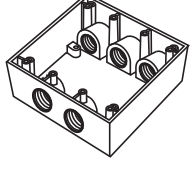
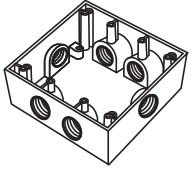
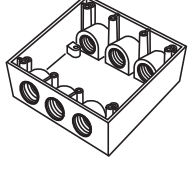
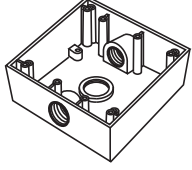
	<b>5 ENTRADAS / 5 HUBS</b>					
	<b>Medida Nominal Size</b>	<b>RAWELT</b>		<b>PERFECT LINE</b>	<b>BWF</b>	
		<b>Código Code</b>	<b>Catalogo Catalog</b>	<b>Catalogo Catalog</b>	<b>Catalogo Catalog</b>	
	1/2	Sin orejas	02.01.0490	RC-0490		
	3/4	W/out lugs	02.01.0491	RC-0491		
1/2	Con orejas	02.01.0490.M	RC-0490-M			
3/4	With lugs	02.01.0491.M	RC-0491-M			
	<b>5 ENTRADAS / 5 HUBS</b>					
	<b>Medida Nominal Size</b>	<b>RAWELT</b>		<b>PERFECT LINE</b>	<b>BWF</b>	
		<b>Código Code</b>	<b>Catalogo Catalog</b>	<b>Catalogo Catalog</b>	<b>Catalogo Catalog</b>	
	1/2	Sin orejas	02.01.0494	RC-0494		
	3/4	W/out lugs	02.01.0495	RC-0495		
1/2	Con orejas	02.01.0494.M	RC-0494-M			
3/4	With lugs	02.01.0495.M	RC-0495-M			
	<b>5 ENTRADAS / 5 HUBS</b>					
	<b>Medida Nominal Size</b>	<b>RAWELT</b>		<b>PERFECT LINE</b>	<b>BWF</b>	
		<b>Código Code</b>	<b>Catalogo Catalog</b>	<b>Catalogo Catalog</b>	<b>Catalogo Catalog</b>	
	1/2	Sin orejas	02.01.0498	RC-0498		
	3/4	W/out lugs	02.01.0499	RC-0499		
1/2	Con orejas	02.01.0498.M	RC-0498-M			
3/4	With lugs	02.01.0499.M	RC-0499-M			
	<b>6 ENTRADAS / 6 HUBS</b>					
	<b>Medida Nominal Size</b>	<b>RAWELT</b>		<b>PERFECT LINE</b>	<b>BWF</b>	
		<b>Código Code</b>	<b>Catalogo Catalog</b>	<b>Catalogo Catalog</b>	<b>Catalogo Catalog</b>	
	1/2	Sin orejas	02.01.0496	RC-0496		
	3/4	W/out lugs	02.01.0497	RC-0497		
1/2	Con orejas	02.01.0496.M	RC-0496-M			
3/4	With lugs	02.01.0497.M	RC-0497-M			
	<b>6 ENTRADAS / 6 HUBS</b>					
	<b>Medida Nominal Size</b>	<b>RAWELT</b>		<b>PERFECT LINE</b>	<b>BWF</b>	
		<b>Código Code</b>	<b>Catalogo Catalog</b>	<b>Catalogo Catalog</b>	<b>Catalogo Catalog</b>	
	1/2	Sin orejas	02.01.0500	RC-0500		
	3/4	W/out lugs	02.01.0501	RC-0501		
1/2	Con orejas	02.01.0500.M	RC-0500-M			
3/4	With lugs	02.01.0501.M	RC-0501-M			
	<b>3 ENTRADAS / 3 HUBS</b>					
	<b>Medida Nominal Size</b>	<b>RAWELT</b>		<b>PERFECT LINE</b>	<b>BWF</b>	
		<b>Código Code</b>	<b>Catalogo Catalog</b>	<b>Catalogo Catalog</b>	<b>Catalogo Catalog</b>	
	1/2	Sin orejas	02.01.0279	RC-0279	LT11	TGB-5
	3/4	W/out lugs	02.01.0280	RC-0280	LT14	TGB-75
1/2	Con orejas	02.01.0279.M	RC-0279-M	LT11-L	TGB-5L	
3/4	With lugs	02.01.0280.M	RC-0280-M	LT14-L	TGB-75L	

**TABLA DE EQUIVALENCIAS.  
CROSS REFERENCE GUIDE.**

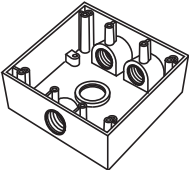
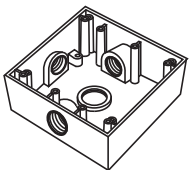
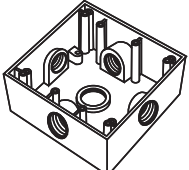
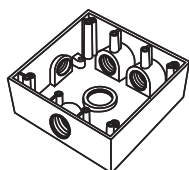
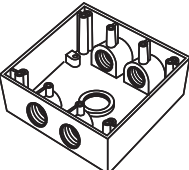
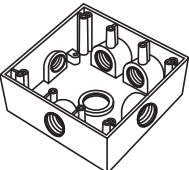
	<b>4 ENTRADAS / 4 HUBS</b>					
	<b>Medida Nominal Size</b>	<b>RAWELT</b>		<b>PERFECT LINE</b>	<b>BWF</b>	
		<b>Código Code</b>	<b>Catalogo Catalog</b>	<b>Catalogo Catalog</b>	<b>Catalogo Catalog</b>	
	1/2	Sin orejas	02.01.0327	RC-0327	LT11-2	TGB-54
	3/4	W/out lugs	02.01.0328	RC-0328	LT14-2	TGB-75-4
	1/2	Con orejas	02.01.0327.M	RC-0327-M	LT11-2L	TGB-5L
3/4	With lugs	02.01.0328.M	RC-0328-M	LT14-2L	TGB-75L	
	<b>4 ENTRADAS / 4 HUBS</b>					
	<b>Medida Nominal Size</b>	<b>RAWELT</b>		<b>PERFECT LINE</b>	<b>BWF</b>	
		<b>Código Code</b>	<b>Catalogo Catalog</b>	<b>Catalogo Catalog</b>	<b>Catalogo Catalog</b>	
	1/2	Sin orejas	02.01.0406	RC-0406		
	3/4	W/out lugs	02.01.0407	RC-0407		
	1/2	Con orejas	02.01.0406.M	RC-0406-M		
3/4	With lugs	02.01.0407.M	RC-0407-M			
	<b>5 ENTRADAS / 5 HUBS</b>					
	<b>Medida Nominal Size</b>	<b>RAWELT</b>		<b>PERFECT LINE</b>	<b>BWF</b>	
		<b>Código Code</b>	<b>Catalogo Catalog</b>	<b>Catalogo Catalog</b>	<b>Catalogo Catalog</b>	
	1/2	Sin orejas	02.01.0390	RC-0390	LTX11-5	TGB-55X
	3/4	W/out lugs	02.01.0391	RC-0391	LTX14-5	TGB-75-5X
	1/2	Con orejas	02.01.0390.M	RC-0390-M	LTX11-5L	TGB-55XL
3/4	With lugs	02.01.0391.M	RC-0391-M	LTX14-5L	TGB-75-5XL	
	<b>5 ENTRADAS / 5 HUBS</b>					
	<b>Medida Nominal Size</b>	<b>RAWELT</b>		<b>PERFECT LINE</b>	<b>BWF</b>	
		<b>Código Code</b>	<b>Catalogo Catalog</b>	<b>Catalogo Catalog</b>	<b>Catalogo Catalog</b>	
	1/2	Sin orejas	02.01.0392	RC-0392		
	3/4	W/out lugs	02.01.0393	RC-0393		
	1/2	Con orejas	02.01.0392.M	RC-0392-M		
3/4	With lugs	02.01.0393.M	RC-0393-M			
	<b>5 ENTRADAS / 5 HUBS</b>					
	<b>Medida Nominal Size</b>	<b>RAWELT</b>		<b>PERFECT LINE</b>	<b>BWF</b>	
		<b>Código Code</b>	<b>Catalogo Catalog</b>	<b>Catalogo Catalog</b>	<b>Catalogo Catalog</b>	
	1/2	Sin orejas	02.01.0396	RC-0396	LT11-3	TGB-55L
	3/4	W/out lugs	02.01.0397	RC-0397	LT14-3	TGB-75-5
	1/2	Con orejas	02.01.0396.M	RC-0396-M	LT11-3L	TGB-55L
3/4	With lugs	02.01.0397.M	RC-0397-M	LT14-3L	TGB-75-5L	
	<b>6 ENTRADAS / 6 HUBS</b>					
	<b>Medida Nominal Size</b>	<b>RAWELT</b>		<b>PERFECT LINE</b>	<b>BWF</b>	
		<b>Código Code</b>	<b>Catalogo Catalog</b>	<b>Catalogo Catalog</b>	<b>Catalogo Catalog</b>	
	1/2	Sin orejas	02.01.0394	RC-0394	LTX11-6	
	3/4	W/out lugs	02.01.0395	RC-0395	LTX14-6	
	1/2	Con orejas	02.01.0394.M	RC-0394-M	LTX11-6L	TGB-56XL
3/4	With lugs	02.01.0395.M	RC-0395-M	LTX14-6L	TGB-75-6XL	

**TABLA DE EQUIVALENCIAS.**  
**CROSS REFERENCE GUIDE.**

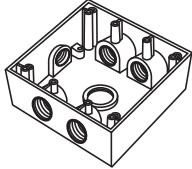
	6 ENTRADAS / 6 HUBS					
	Medida Nominal Size	RAWELT		PERFECT LINE	BWF	
		Código Code	Catalogo Catalog	Catalogo Catalog	Catalogo Catalog	
	1/2	Sin orejas	02.01.0398	RC-0398		
	3/4	W/out lugs	02.01.0399	RC-0399		
	1/2	Con orejas	02.01.0398.M	RC-0398-M		
	3/4	With lugs	02.01.0399.M	RC-0399-M		

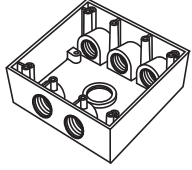

	6 ENTRADAS / 6 HUBS					
	Medida Nominal Size	RAWELT		PERFECT LINE	BWF	
		Código Code	Catalogo Catalog	Catalogo Catalog	Catalogo Catalog	
	1/2	Sin orejas	02.01.0402	RC-0402		
	3/4	W/out lugs	02.01.0403	RC-0403		
	1/2	Con orejas	02.01.0402.M	RC-0402-M		
	3/4	With lugs	02.01.0403.M	RC-0403-M		

	7 ENTRADAS / 7 HUBS					
	Medida Nominal Size	RAWELT		PERFECT LINE	BWF	
		Código Code	Catalogo Catalog	Catalogo Catalog	Catalogo Catalog	
	1/2	Sin orejas	02.01.0400	RC-0400	LTX11-7	
	3/4	W/out lugs	02.01.0401	RC-0401	LTX14-7	
	1/2	Con orejas	02.01.0400.M	RC-0400-M	LTX11-7L	
	3/4	With lugs	02.01.0401.M	RC-0401-M	LTX14-7L	

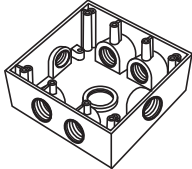
	7 ENTRADAS / 7 HUBS					
	Medida Nominal Size	RAWELT		PERFECT LINE	BWF	
		Código Code	Catalogo Catalog	Catalogo Catalog	Catalogo Catalog	
	1/2	Sin orejas	02.01.0404	RC-0404	LT11-33	TGB-57
	3/4	W/out lugs	02.01.0405	RC-0405	LT14-33	TGB-77
	1/2	Con orejas	02.01.0404.M	RC-0404-M	LT11-33L	TGB-57L
	3/4	With lugs	02.01.0405.M	RC-0405-M	LT14-33L	TGB-77L

Rawelt, S.A. de C.V. no asume ninguna responsabilidad por omisiones, errores, diferencias, en el diseño o función entre los productos arriba mencionados.

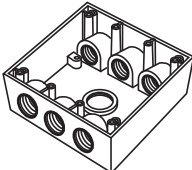
Rawelt, S.A. de C.V. assumes no liability for omission, errors, differences between bodies above mentioned or change in design or function.

Cotización/Quotation  Plazo de embarque\* / Shipment exw\* :

Pedido No./Purchase order : .....

Our ref.: .....

Fecha/Date: ..... Vendedor/Salesman: ..... No. ....

Facturar a/Invoice to: ..... RFC. ....

Ordenado por/Ordered by: ..... Tel. ( ) ..... Fax ( ) .....

Dirección/Address: .....

..... C.P./Zip. .... Lugar/City/Country: .....























Consignar a/Ship to: .....

..... Embarcar: Camión  x Cobrar  Pagado  Paquete

Cond. de Pago/Terms: .....

Cond. de Venta/Sale conditions: ..... L.P.: .....

**4.2 - SERIE RC. CAJA CUADRADA A PRUEBA DE INTEMPERIE. CON OREJAS DE MONTAJE / WEATHERPROOF TWO GANG BOX. WITH M. LUGS**

Figura Figure	Código Code	Medida nominal Hub size		Pqt. Unit. Pzas. Pcs.	Unit. Ctn. Pzas. Pcs.	Ship Ctn. Pzas. Pcs.	Std. Pkg. Pzas. Pcs.	Cantidad Qty.	Figura Figure	Código Code	Medida nominal Hub size		Pqt. Unit. Pzas. Pcs.	Std. Pkg. Pzas. Pcs.	Cantidad Qty.
		mm	inch								mm	inch			
	02.01.0482.M	12.7	1/2	1			24			02.01.0279.M	12.7	1/2	1	24	
	02.01.0483.M	19.0	3/4	1			24			02.01.0280.M	19.0	3/4	1	24	
	02.01.0484.M	12.7	1/2	1			24			02.01.0327.M	12.7	1/2	1	24	
	02.01.0485.M	19.0	3/4	1			24			02.01.0328.M	19.0	3/4	1	24	
	02.01.0502.M	12.7	1/2	1			24			02.01.0406.M	12.7	1/2	1	24	
	02.01.0503.M	19.0	3/4	1			24			02.01.0407.M	19.0	3/4	1	24	
	02.01.0486.M	12.7	1/2	1			24			02.01.0390.M	12.7	1/2	1	24	
	02.01.0487.M	19.0	3/4	1			24			02.01.0391.M	19.0	3/4	1	24	
	02.01.0488.M	12.7	1/2	1			24			02.01.0392.M	12.7	1/2	1	24	
	02.01.0489.M	19.0	3/4	1			24			02.01.0393.M	19.0	3/4	1	24	
	02.01.0492.M	12.7	1/2	1			24			02.01.0396.M	12.7	1/2	1	24	
	02.01.0493.M	19.0	3/4	1			24			02.01.0397.M	19.0	3/4	1	24	
	02.01.0490.M	12.7	1/2	1			24			02.01.0394.M	12.7	1/2	1	24	
	02.01.0491.M	19.0	3/4	1			24			02.01.0395.M	19.0	3/4	1	24	
	02.01.0494.M	12.7	1/2	1			24			02.01.0398.M	12.7	1/2	1	24	
	02.01.0495.M	19.0	3/4	1			24			02.01.0399.M	19.0	3/4	1	24	
	02.01.0498.M	12.7	1/2	1			24			02.01.0402.M	12.7	1/2	1	24	
	02.01.0499.M	19.0	3/4	1			24			02.01.0403.M	19.0	3/4	1	24	
	02.01.0496.M	12.7	1/2	1			24			02.01.0400.M	12.7	1/2	1	24	
	02.01.0497.M	19.0	3/4	1			24			02.01.0401.M	19.0	3/4	1	24	
	02.01.0500.M	12.7	1/2	1			24			02.01.0404.M	12.7	1/2	1	24	
	02.01.0501.M	19.0	3/4	1			24			02.01.0405.M	19.0	3/4	1	24	
	01.04.0371.M	12.7	1/2	25	200	2000									
	01.04.0368.M	19.0	3/4	25	100	1000									

Expediente  
 Control  
 Embarques  
 Almacén  
 Producción

- Antes de fincar el pedido en firme, favor de confirmar con fábrica el plazo de embarque definitivo.
- Before place your order, please confirm with RAWELT definitive date of shipment.

Cotización/Quotation  Plazo de embarque\* / Shipment exw\* :

Pedido No./Purchase order : .....

Our ref.: .....

Fecha/Date: ..... Vendedor/Salesman: ..... No. ....

Facturar a/Invoice to: ..... RFC: .....

Ordenado por/Ordered by: ..... Tel. ( ) ..... Fax ( ) .....

Dirección/Address: .....

C.P./Zip: ..... Lugar/City/Country: .....

Consignar a/Ship to: .....

Embarcar: Camión  x Cobrar  Pagado  Paquete

Cond. de Pago/Terms: .....

Cond. de Venta/Sale conditions: ..... L.P.: .....

3. - SERIE RR. TAPA ALUMINIO Y EMPAQUE ALUMINUM COVER AND GASKET.							4. - SERIE RC. TAPA ALUMINIO Y EMPAQUE ALUMINUM COVER AND GASKET.							
Figura Figure	Código Code	Diametro Ø	Pqt. Unit. Pzas. Pcs.	Unit. Ctn. Pzas. Pcs.	Ship. Ctn. Pzas. Pcs.	Std. Pkg. Pzas. Pcs.	Cantidad Qty.	Figura Figure	Código Code	Pqt. Unit. Pzas. Pcs.	Unit. Ctn. Pzas. Pcs.	Ship. Ctn. Pzas. Pcs.	Std. Pkg. Pzas. Pcs.	Cantidad Qty.
	01.02.0424	Ø 35.23 mm	10	50	200	400			02.02.0417	10	40	160	200	
	01.02.0414	Ø 40.38 mm	10	50	200	400			02.02.0457	10	40	160	200	
	01.02.0426	Ø 54.30 mm	10	50	200	400			02.02.0419	10	40	160	200	
	01.02.0425	Ø 35.23 mm	10	50	200	400			02.02.0459	10	40	160	200	
	01.02.0423	Ø 40.38 mm	10	50	200	400			02.02.0510	10	40	160	200	
	01.02.0427	Ø 54.30 mm	10	50	200	400			02.02.0511	10	40	160	200	
	01.02.0415		10	50	200	400			02.02.1311.G	10	40	120	200	
	01.02.0421		10	50	200	400			02.02.1312.G	10	40	120	200	
	01.02.0385		10	50	200	400			02.04.0430 1/16	10	120	480		
	01.02.0422		10	50	200	400								
	01.02.1309.G		10	40	160	330								
	01.02.1310.G		10	40	160	330								
	01.05.0429 1/16		10	100	700									

Expediente  
 Control  
 Embarques  
 Almacén  
 Producción

- Antes de fincar el pedido en firme, favor de confirmar con fábrica el plazo de embarque definitivo.
- Before place your order, please confirm with RAWELT definitive date of shipment.

Cotización/Quotation  Plazo de embarque\* / Shipment exw\* :

 Pedido No./Purchase order : .....

Our ref.: .....

Fecha/Date: ..... Vendedor/Salesman: ..... No. ....

Facturar a/Invoice to: ..... RFC: .....

Ordenado por/Ordered by: ..... Tel. ( ) ..... Fax ( ) .....

Dirección/Address: .....



C.P./Zip: ..... Lugar/City/Country: .....

Consignar a/Ship to: .....

 Embarcar: Camión  x Cobrar  Pagado  Paquete 

Cond. de Pago/Terms: .....

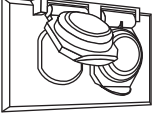
Cond. de Venta/Sale conditions: ..... L.P.: .....

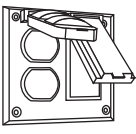
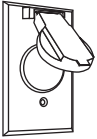
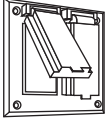
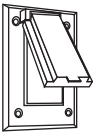
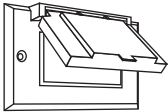
3.- SERIE RR. TAPA A PRUEBA DE INTEMPERIE/WEATHERPROOF COVER.							4.- SERIE RC. TAPA A PRUEBA DE INTEMPERIE/WEATHERPROOF COVER.						
Figura Figure	Código Code	Pqt. Unit. Pzas. Pcs.	Unit. Ctn. Pzas. Pcs.	Ship. Ctn. Pzas. Pcs.	Std. Pkg. Pzas. Pcs.	Cantidad Qty.	Figura Figure	Código Code	Pqt. Unit. Pzas. Pcs.	Unit. Ctn. Pzas. Pcs.	Ship. Ctn. Pzas. Pcs.	Std. Pkg. Pzas. Pcs.	Cantidad Qty.
	01.03.0611	1	12	48	96			02.03.0568	1	8	32	64	
	01.03.0567	1	12	48	96			02.03.3252	1	8	32	64	
	01.03.0563	1	12	48	96			02.03.3253	1	8	32	64	
	01.03.0565	1	12	48	96								
	01.03.3251	1	12	48	96								

 Expediente   
 Control   
 Embarques   
 Almacén   
 Producción 

- Antes de fincar el pedido en firme, favor de confirmar con fábrica el plazo de embarque definitivo.
- Before place your order, please confirm with RAWELT definitive date of shipment.

Cotización/Quotation  Plazo de embarque\* / Shipment exw\*  :

 Pedido No./Purchase order  : \_\_\_\_\_

Our ref.: \_\_\_\_\_

Fecha/Date: \_\_\_\_\_ Vendedor/Salesman: \_\_\_\_\_ No. \_\_\_\_\_

Facturar a/Invoice to: \_\_\_\_\_ RFC: \_\_\_\_\_

Ordenado por/Ordered by: \_\_\_\_\_ Tel. ( ) \_\_\_\_\_ Fax ( ) \_\_\_\_\_

Dirección/Address: \_\_\_\_\_











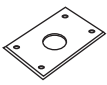
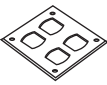
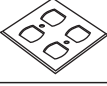
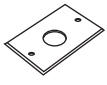
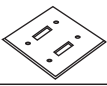

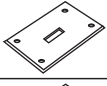
\_\_\_\_\_ C.P./Zip. \_\_\_\_\_ Lugar/City/Country: \_\_\_\_\_

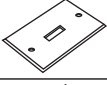
Consignar a/Ship to: \_\_\_\_\_

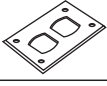
 \_\_\_\_\_ Embarcar: Camión  x Cobrar  Pagado  Paquete 

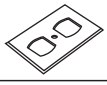
Cond. de Pago/Terms: \_\_\_\_\_

Cond. de Venta/Sale conditions: \_\_\_\_\_ L.P.: \_\_\_\_\_

3. - SERIE RR. TAPA INOXIDABLE Y EMPAQUE STAINLESS STEEL COVER AND GASKET.							4. - SERIE RC. TAPA INOXIDABLE Y EMPAQUE STAINLESS STEEL COVER AND GASKET.							
Figura Figure	Código Code	Diametro Ø	Pqt. Unit. Pzas. Pcs.	Unit. Ctn. Pzas. Pcs.	Ship. Ctn. Pzas. Pcs.	Std. Pkg. Pzas. Pcs.	Cantidad Qty.	Figura Figure	Código Code	Pqt. Unit. Pzas. Pcs.	Unit. Ctn. Pzas. Pcs.	Ship. Ctn. Pzas. Pcs.	Std. Pkg. Pzas. Pcs.	Cantidad Qty.
	01.02.4035.IX	Ø 35.23 mm	10	50	200	400			02.02.4047.IX	10	40	160	200	
	01.02.4036.IX	Ø 40.38 mm	10	50	200	400			02.02.4048.IX	10	40	160	200	
	01.02.4037.IX	Ø 54.30 mm	10	50	200	400				02.02.4049.IX	10	40	160	
	01.02.4038.IX	Ø 35.23 mm	10	50	200	400		02.02.4050.IX		10	40	160	200	
	01.02.4039.IX	Ø 40.38 mm	10	50	200	400		02.02.4051.IX	10	40	160	200		
	01.02.4040.IX	Ø 54.30 mm	10	50	200	400			02.02.4052.IX	10	40	160	200	
	01.02.4041.IX		10	50	200	400			02.02.4053.IX	10	40	120	200	
	01.02.4042.IX		10	50	200	400			02.02.4054.IX	10	40	120	200	
	01.02.4043.IX		10	50	200	400			08.06.3972 1/8	10	120	480		
	01.02.4044.IX		10	50	200	400								
	01.02.4045.IG		10	40	160	330								
	01.02.4046.IG		10	40	160	330								
	08.06.0614 1/8		5	50	350									

 Expediente   
 Control   
 Embarques   
 Almacén   
 Producción 

- Antes de fincar el pedido en firme, favor de confirmar con fábrica el plazo de embarque definitivo.
- Before place your order, please confirm with RAWELT definitive date of shipment.